



SPECIFICATIONS

Single control
Chrome
360° swivel spout
Anti limescale aerator M 22 x 1
ø 3/8" stainless steel flexible pipe
50% two step cartridge for water saving
Packaging: 41,5 x 16 x 7,5 cm / 0,00498 m³ / 1,54 kg

CERTIFICATIONS



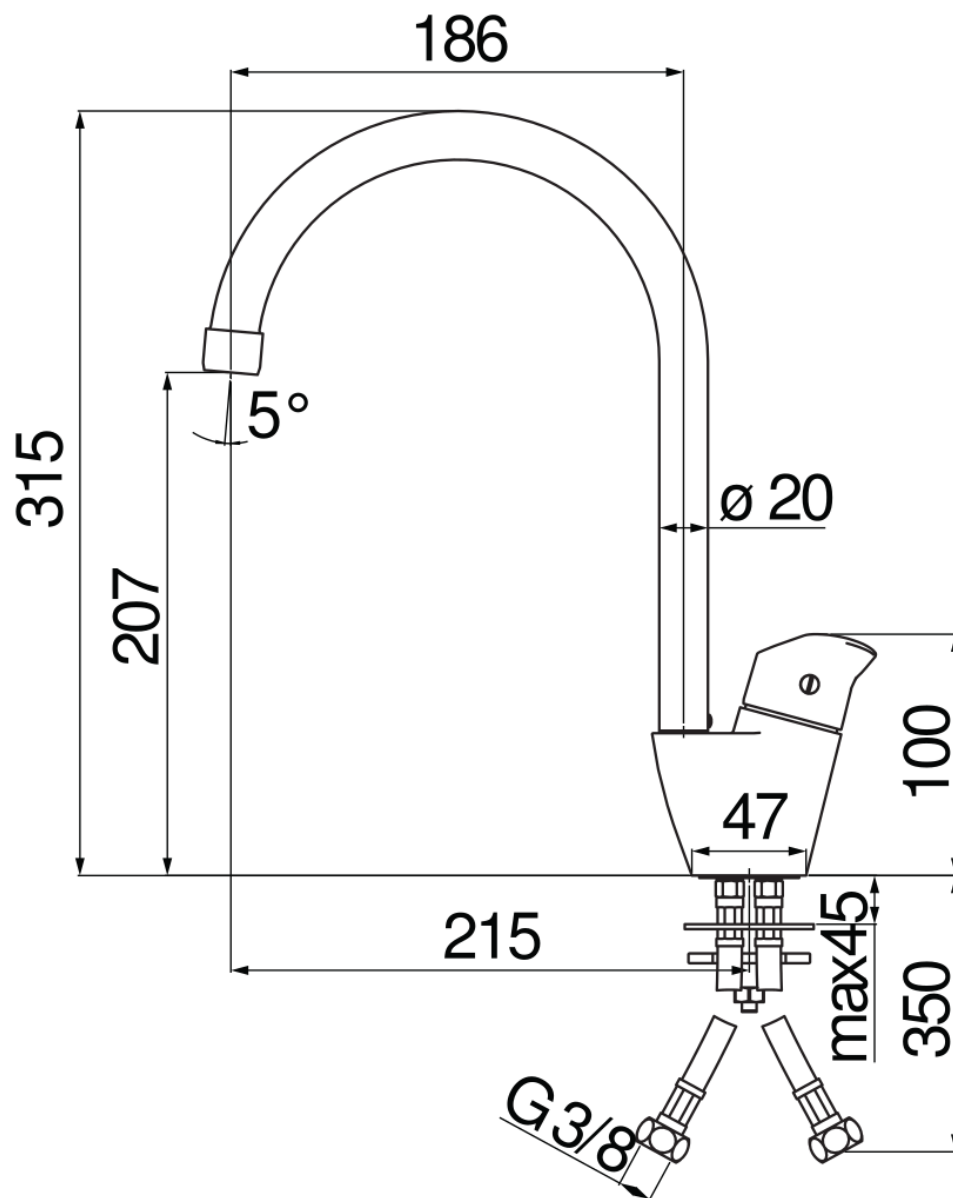

FLOW RATE DIAGRAM: HOT/COLD WATER

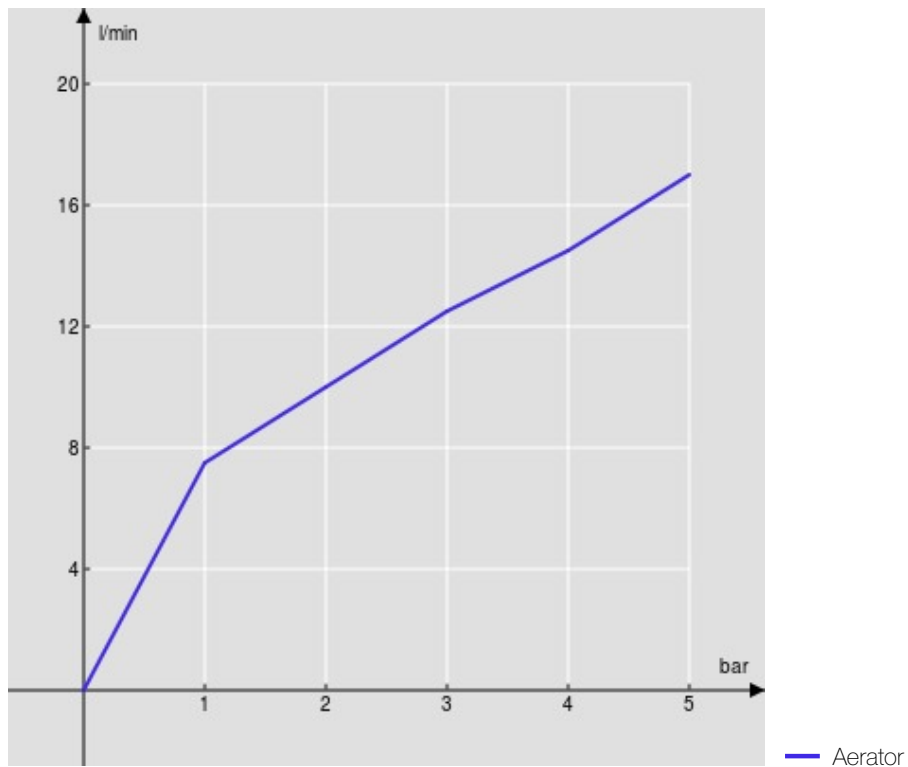

FLOW RATE DIAGRAM: MIXED WATER

